

DWG. TITLE VIDEO WALL		JOB NO 4634-800	
		SCALE NONE	
DWG. NO K604		ENGINEER MSF	
		DRAWN BY MSF	DATE 12/12/19
REV. 2	CHECKED BY	DATE	SHEET NO 5 OF 18

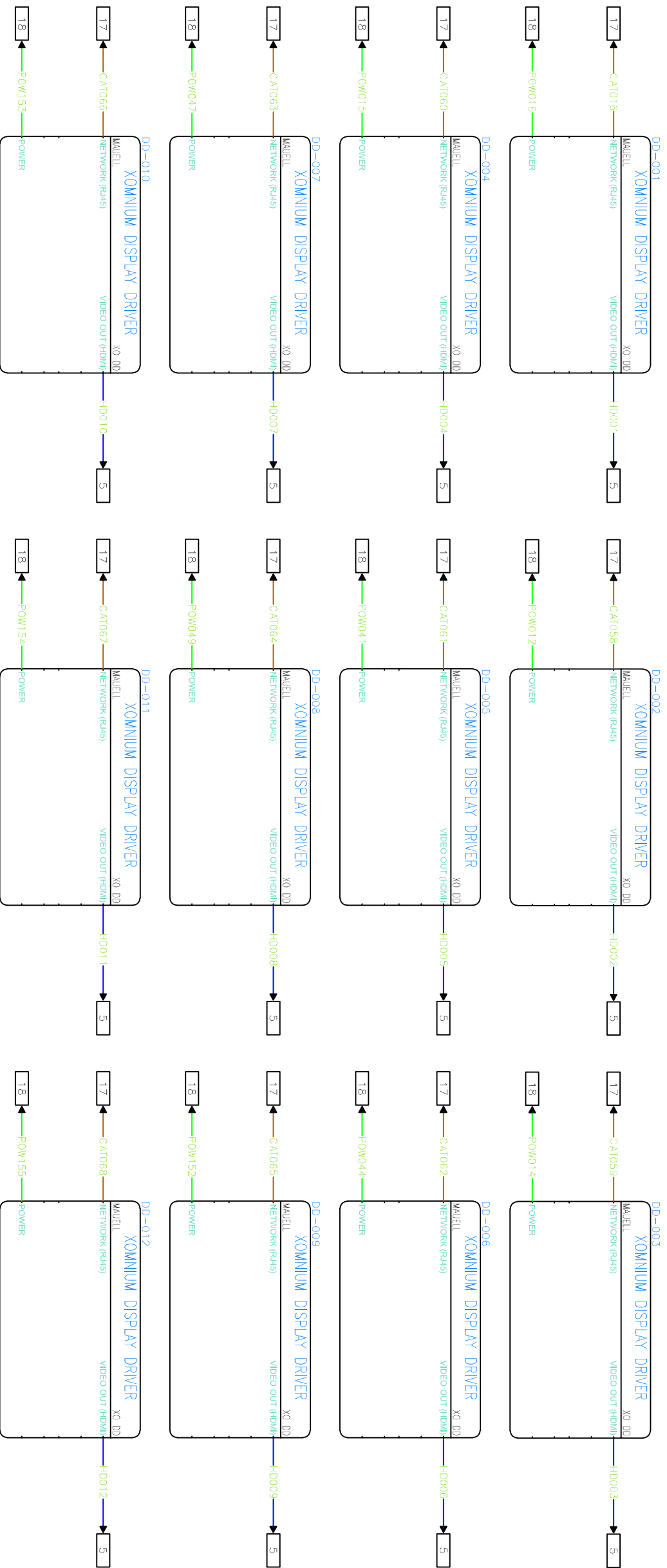

JOB NO 4634-800		SCALE NONE	
		ENGINEER MSF	
DRAWN BY MSF		DATE 12/12/19	
DWG NO K605		REV. 2	
SHEET NO 6 OF 18		CHECKED BY DATE	

DWG TITLE
VIDEO WALL CONTROLLER

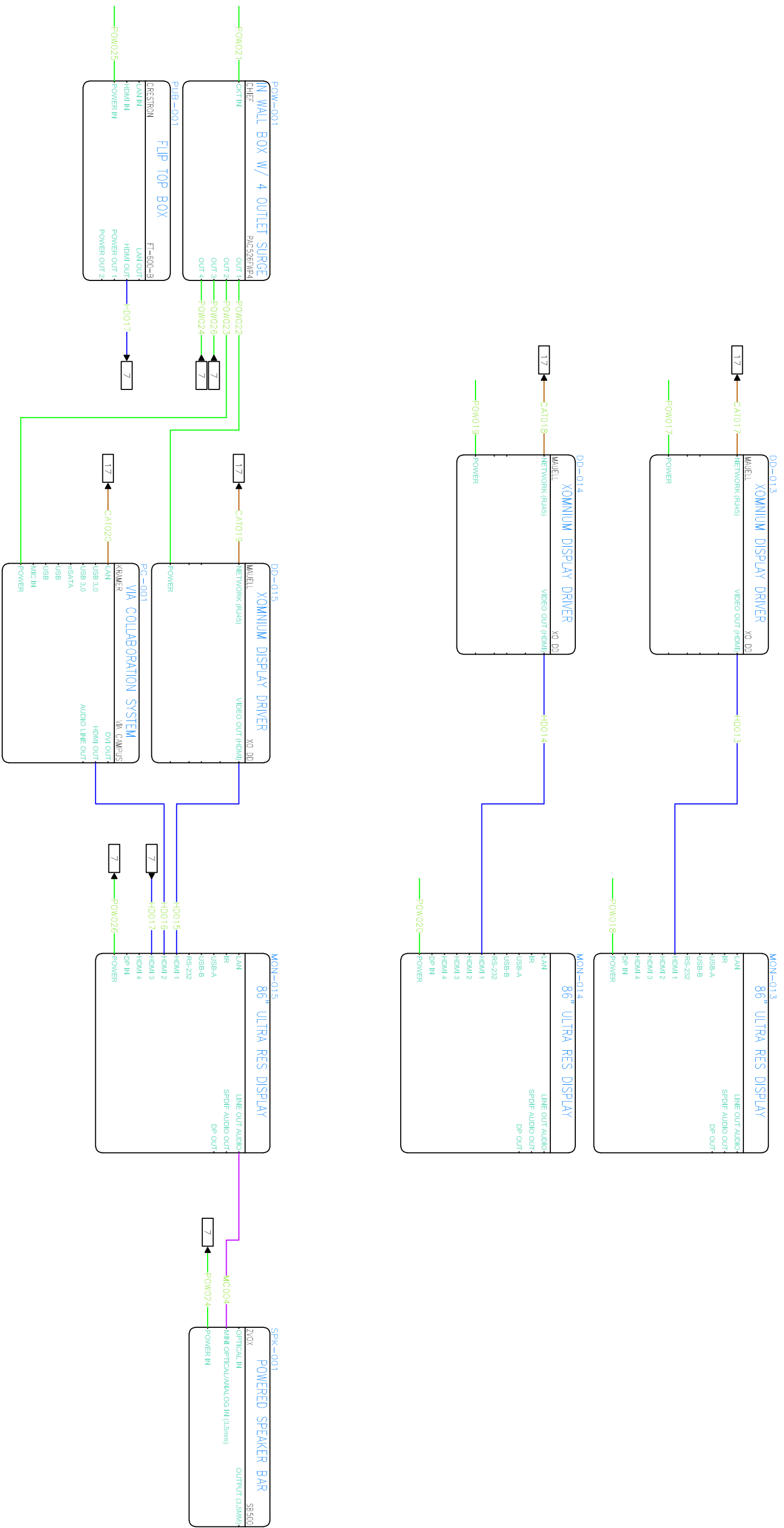

JOB NO	4634-800
SCALE	NONE
ENGINEER	MSF
DRAWN BY	MSF
DATE	12/12/19
CHECKED BY	
DATE	
SHEET NO	7 OF 18

DWG TITLE	
FLANKING DISPLAYS	
DWG NO	K606
REV.	2

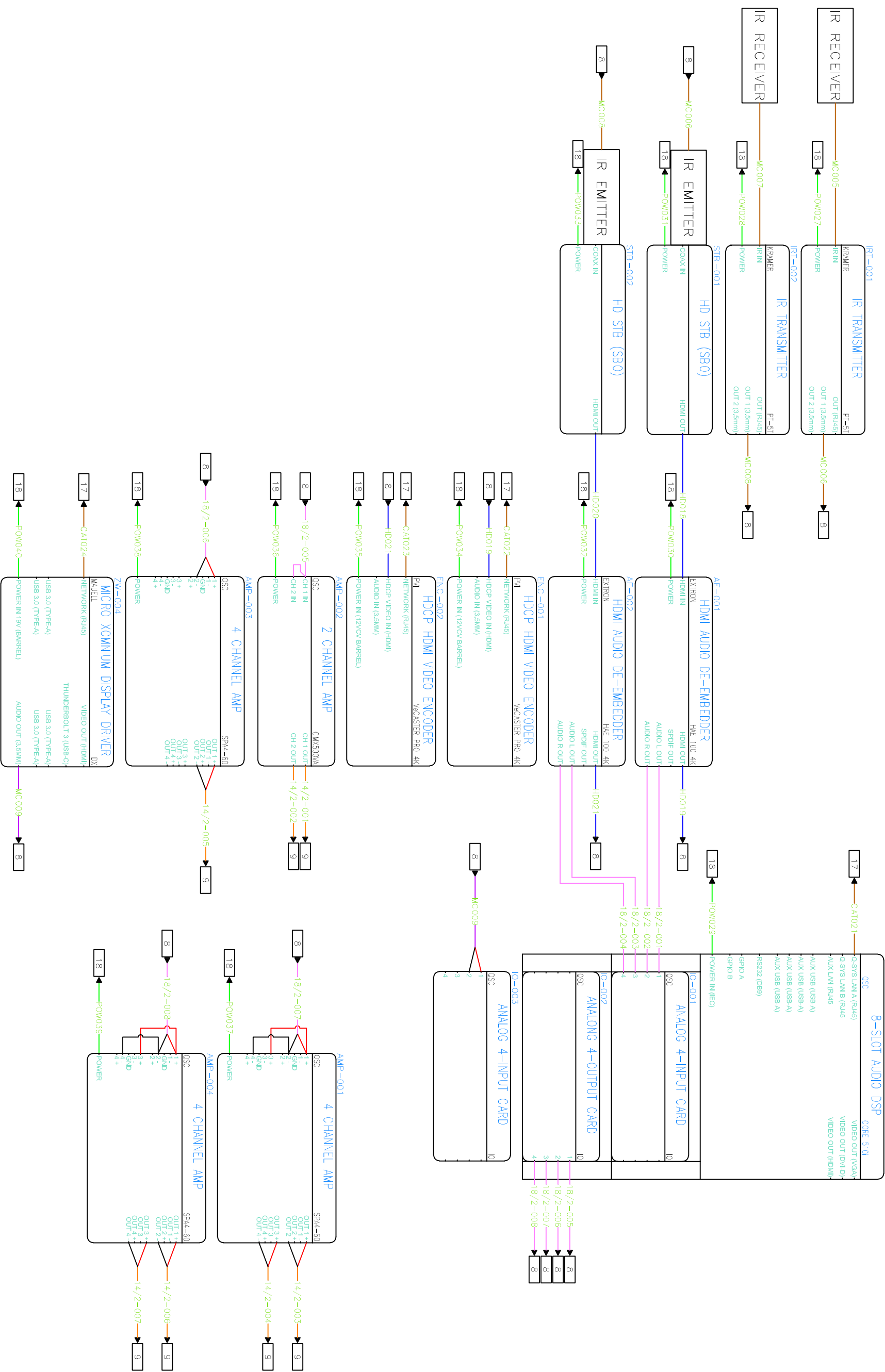

JOB NO 4634-800		SCALE NONE	
ENGINEER MSF		DATE 12/12/19	
DRAWN BY MSF		CHECKED BY DATE	
DWG NO K607	REV. 2	SHEET NO 8 OF 18	

DWG TITLE
AUDIO SYSTEM & SOURCES

CONTROL ROOM OVERHEAD SPEAKERS

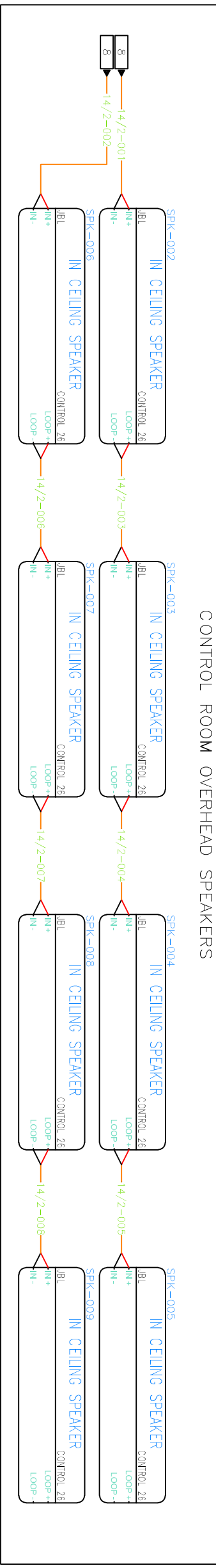

CONFERENCE ROOM OVERHEAD SPEAKERS

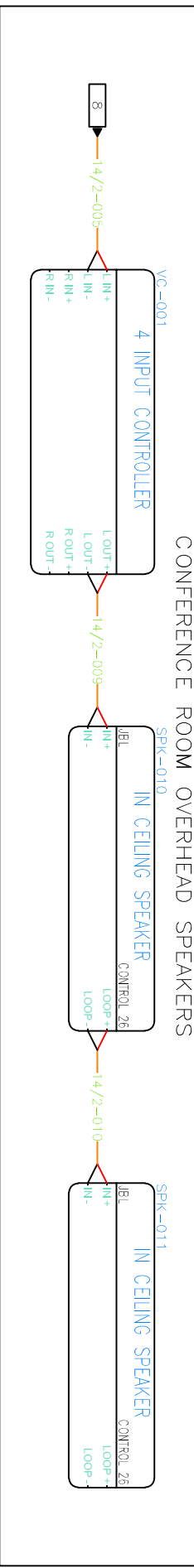

KITCHEN OVERHEAD SPEAKER

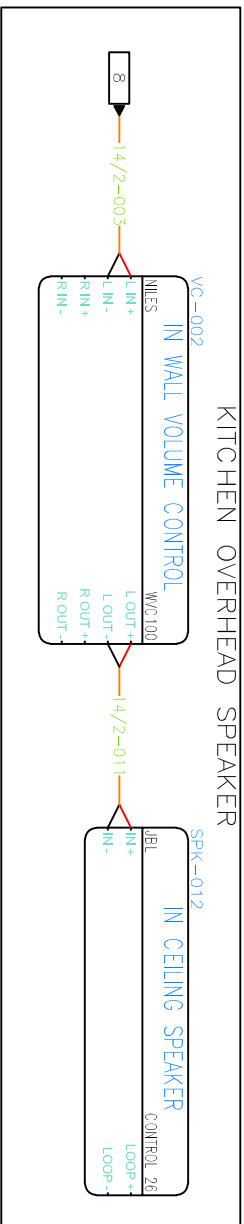

OFFICE OVERHEAD SPEAKER

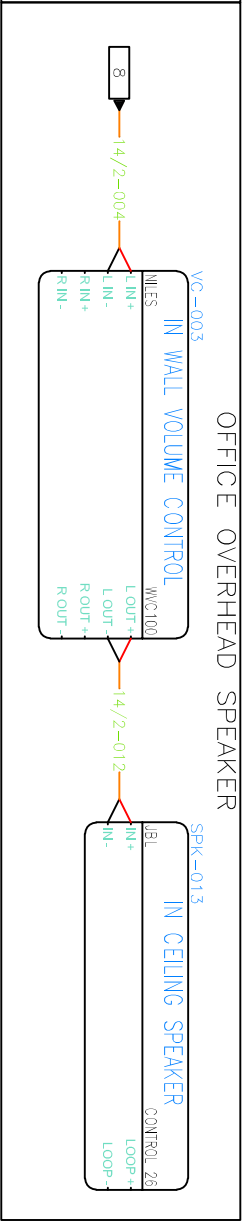

RESTROOM #1 OVERHEAD SPEAKER

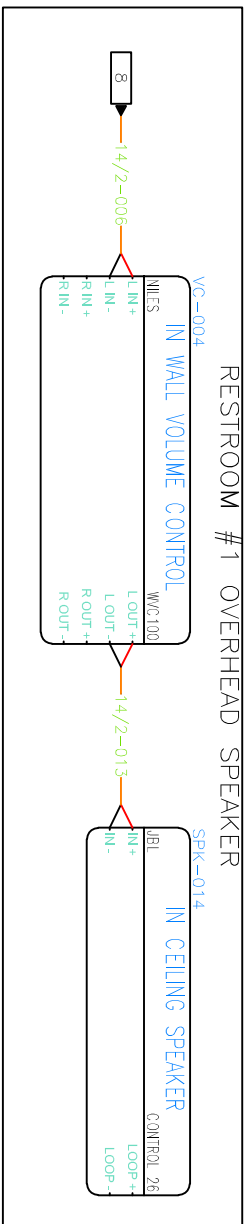

RESTROOM #2 OVERHEAD SPEAKER

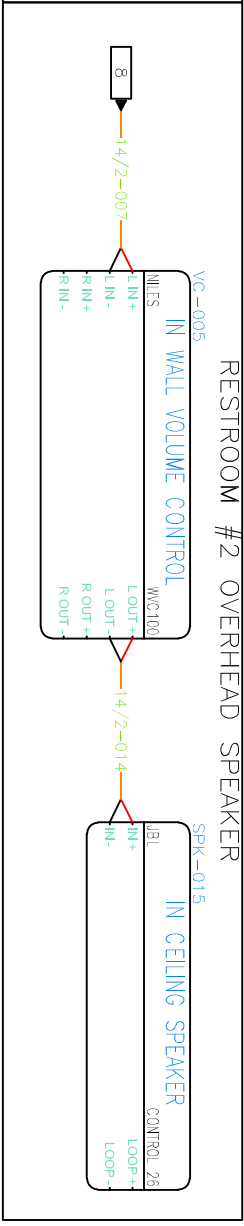

JOB NO 4634-800		SCALE NONE	
ENGINEER MSF		DRAWN BY MSF	
DATE 12/12/19		CHECKED BY DATE	
SHEET NO 9 OF 18		REV. 2	
DWG TITLE OVERHEAD SPEAKERS		DWG NO K608	

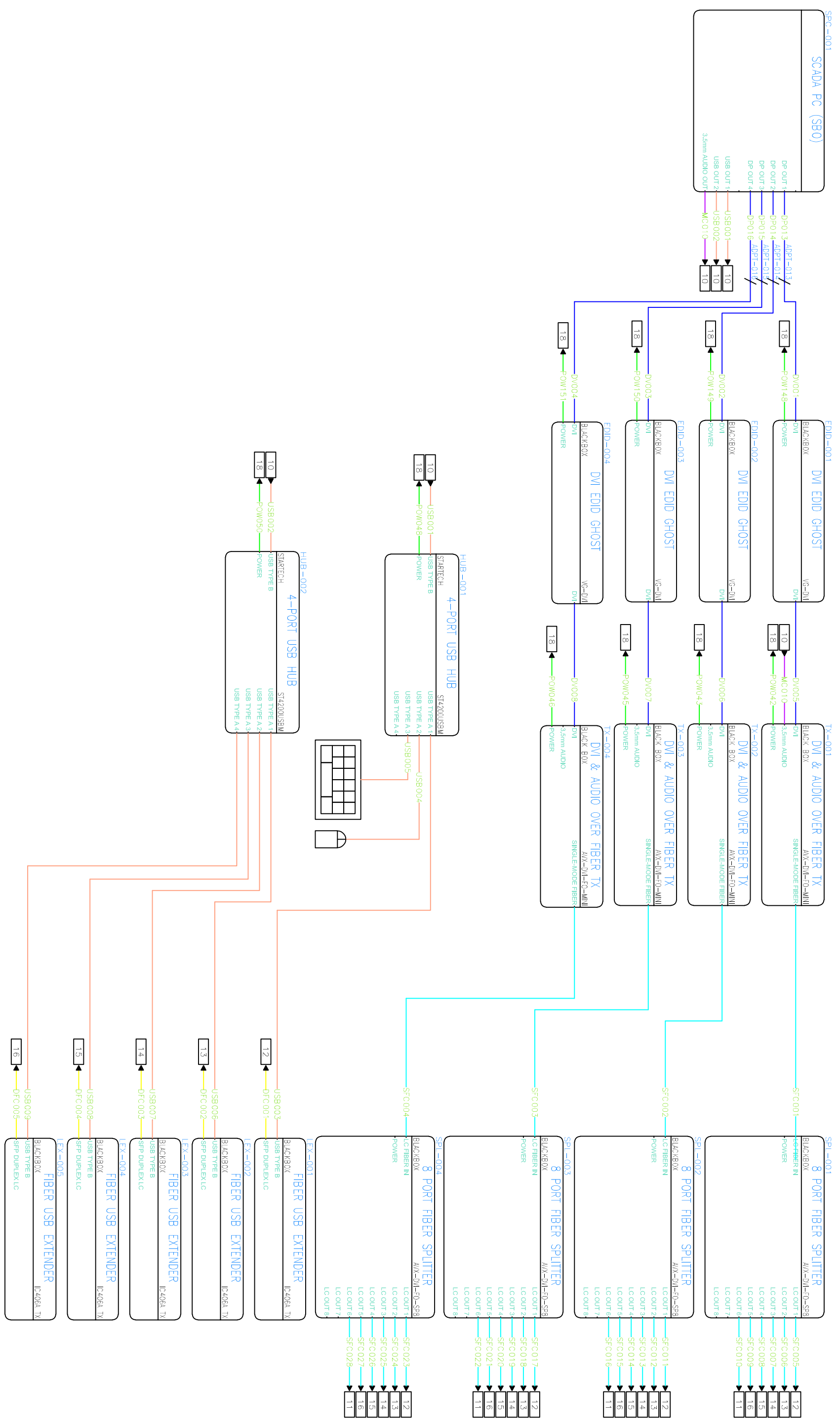

JOB NO 4634-800	
SCALE NONE	
ENGINEER MSF	
DRAWN BY MSF	DATE 12/12/19
CHECKED BY	DATE
SHEET NO 10 OF 18	

DWG TITLE SCADA SERVER	REV. 2
DWG NO K609	

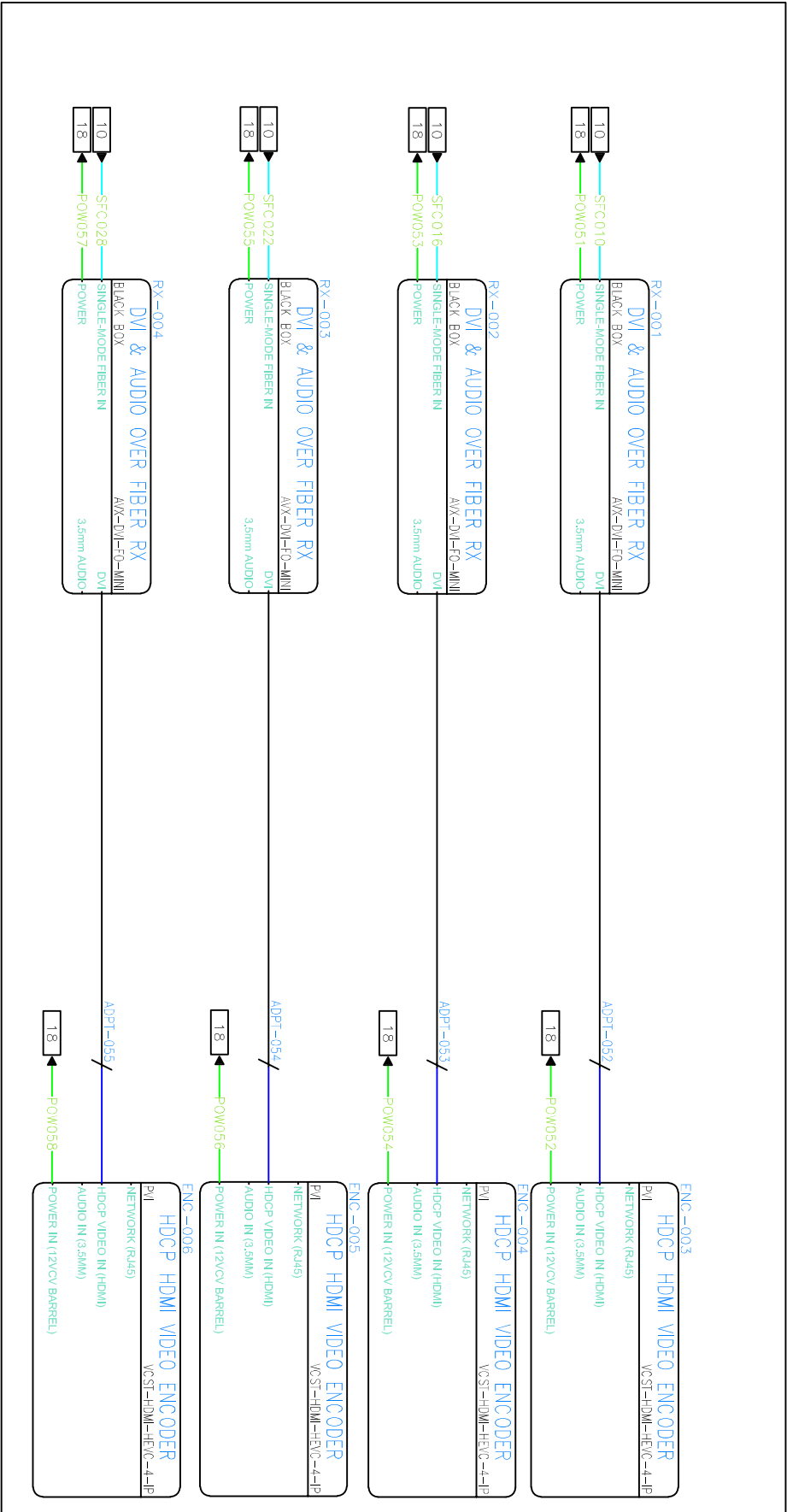

DWG TITLE SCADA SERVER ENCODERS		JOB NO 4634-800
		SCALE NONE
DWG NO K610		ENGINEER MSF
		DRAWN BY MSF
REV. 2	DATE 12/12/19	DATE
		CHECKED BY
		DATE
		SHEET NO 11 OF 18

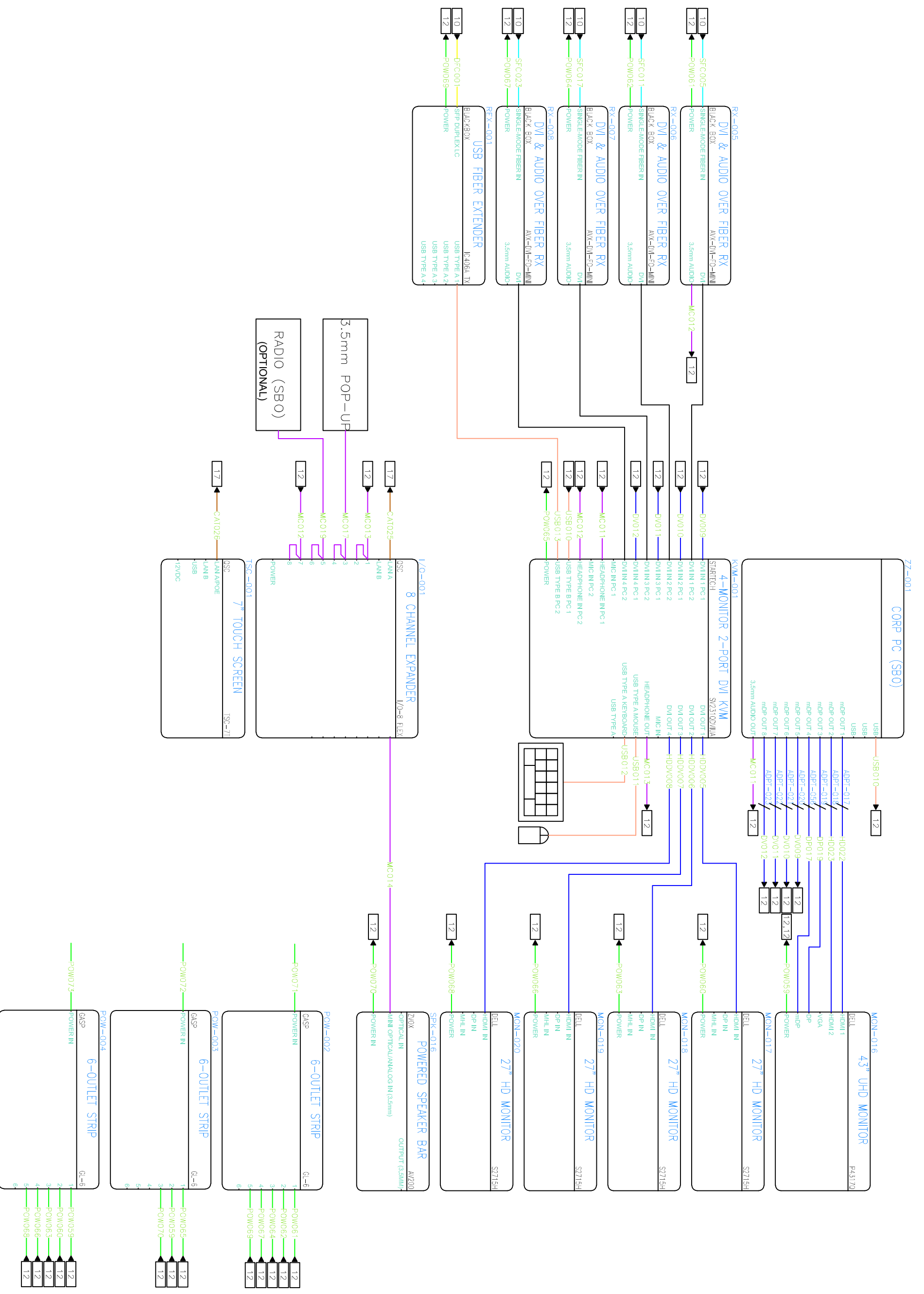

JOB NO 4634-800		
SCALE NONE		
ENGINEER MSF		
DRAWN BY MSF		
DATE 12/12/19		SHEET NO 12 OF 18
CHECKED BY	DATE	
REV. 2		
DWG TITLE CONSOLE 1		DWG NO K611

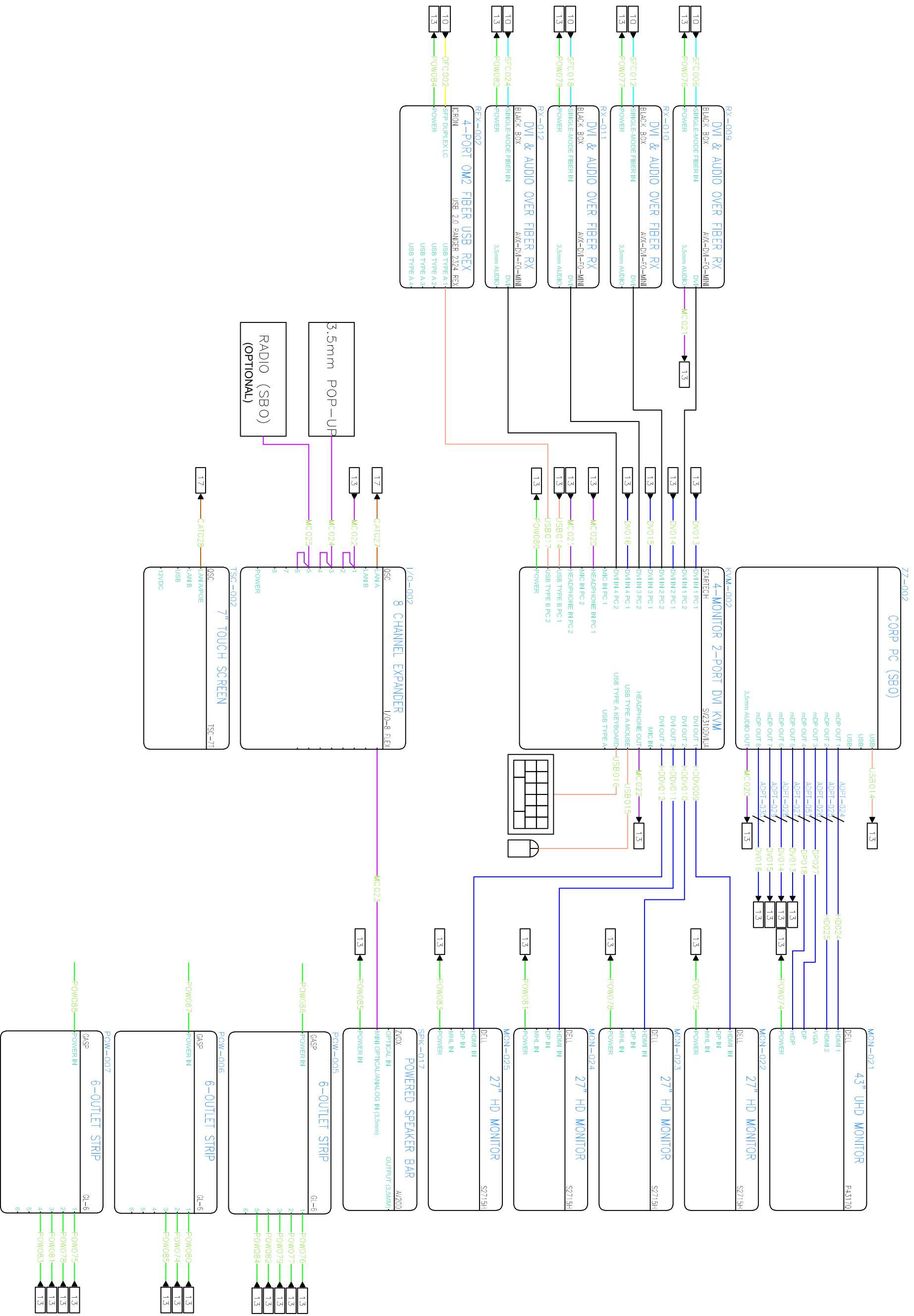

JOB NO	4634-800
SCALE	NONE
ENGINEER	MSF
DRAWN BY	MSF
DATE	12/12/19
CHECKED BY	
DATE	
SHEET NO	13 OF 18

DWG TITLE	CONSOLE 2
DWG NO	K612
REV.	2

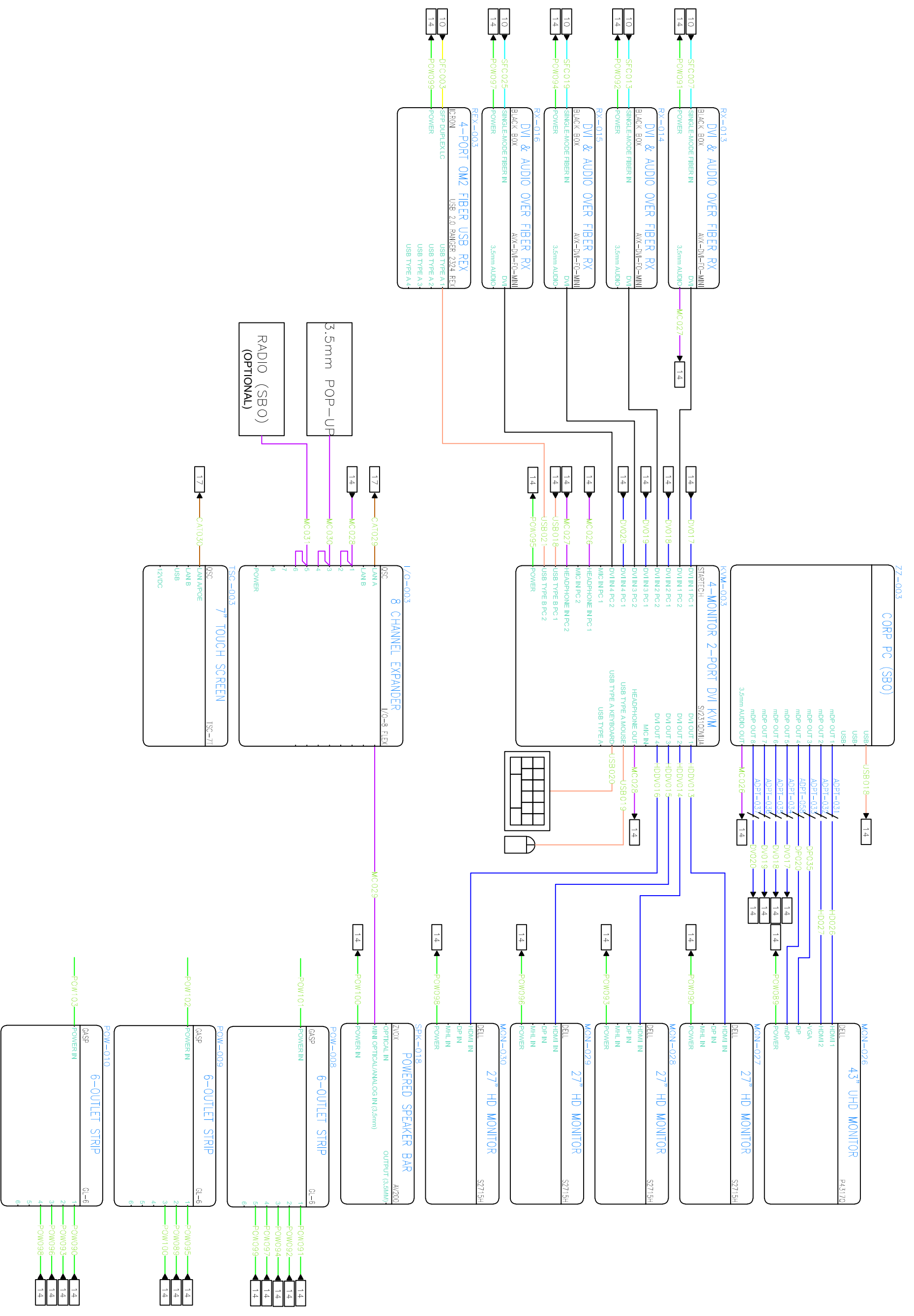

JOB NO	4634-800
SCALE	NONE
ENGINEER	MSF
DRAWN BY	MSF
DATE	12/12/19
CHECKED BY	
DATE	
SHEET NO	14 OF 18

DWG TITLE	CONSOLE 3	
DWG NO	K613	REV. 2

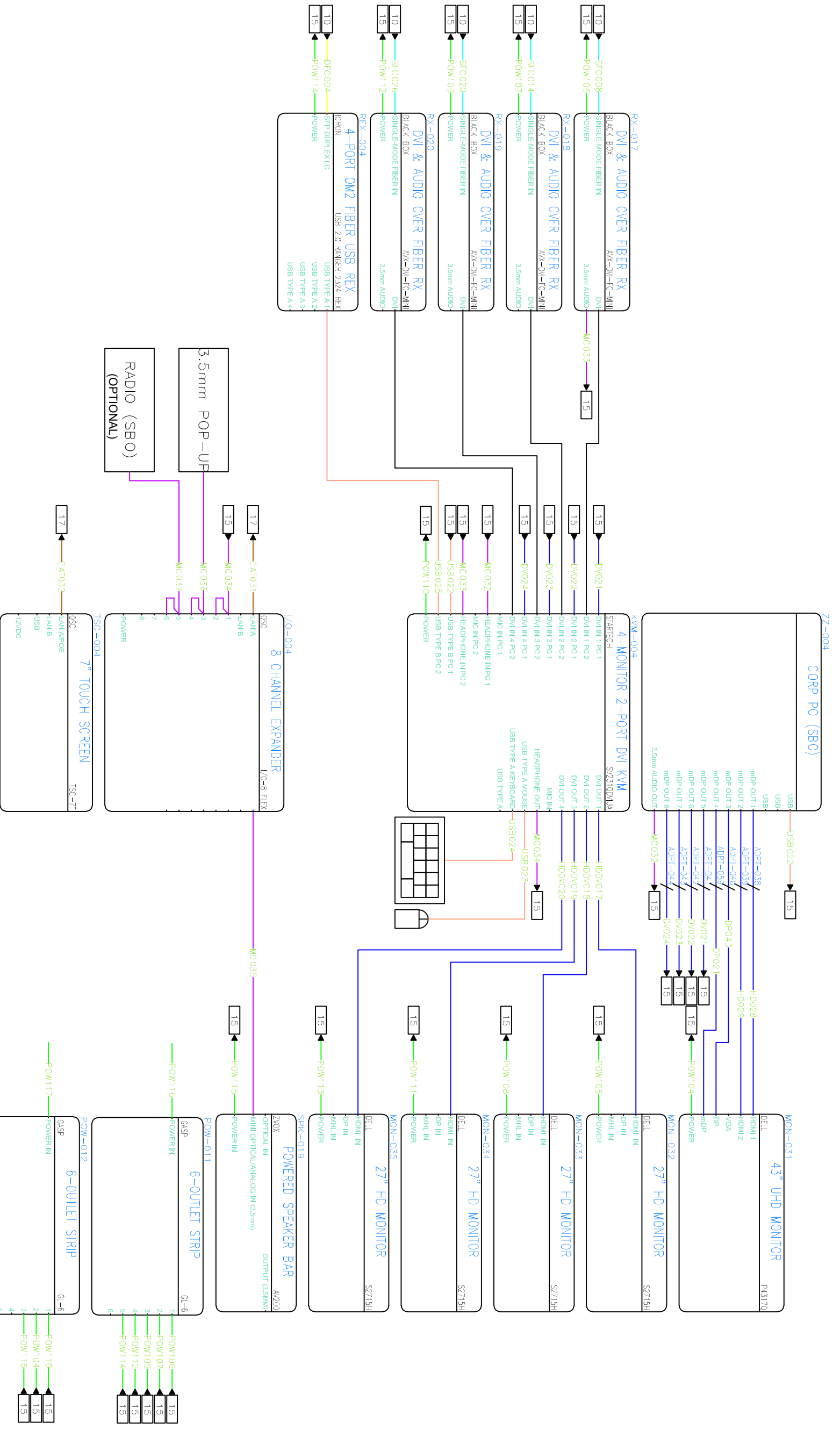

JOB NO 4634-800	
SCALE NONE	
ENGINEER MSF	
DRAWN BY MSF	DATE 12/12/19
CHECKED BY	DATE
SHEET NO 15 OF 18	

DWG TITLE CONSOLE 4	
DWG NO K614	REV. 2

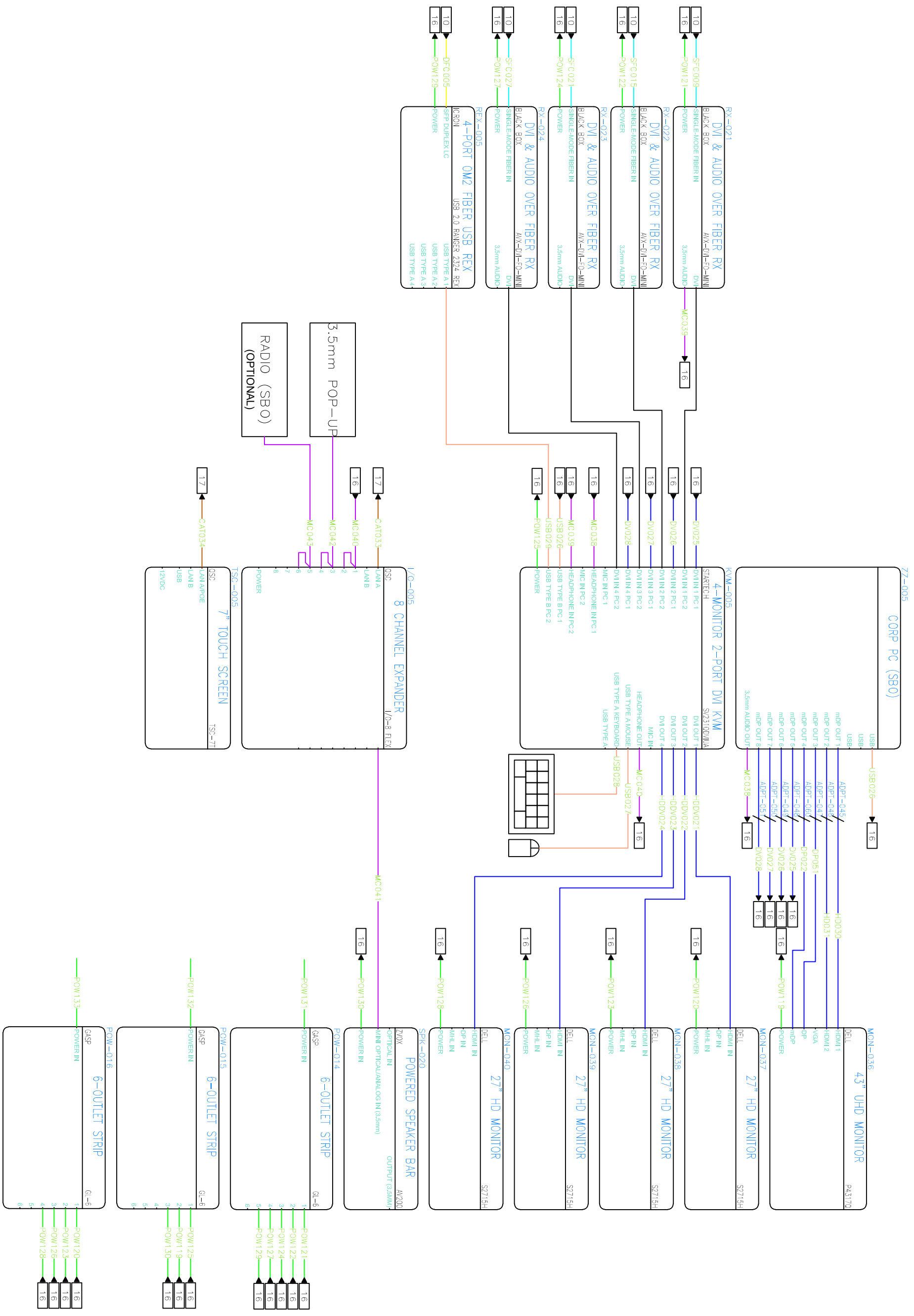

JOB NO 4634-800		
SCALE NONE		
ENGINEER MSF		
DRAWN BY MSF	DATE 12/12/19	
DWG NO K615	REV. 2	CHECKED BY DATE
SHEET NO 16 OF 18		

DWG TITLE
CONSOLE 5

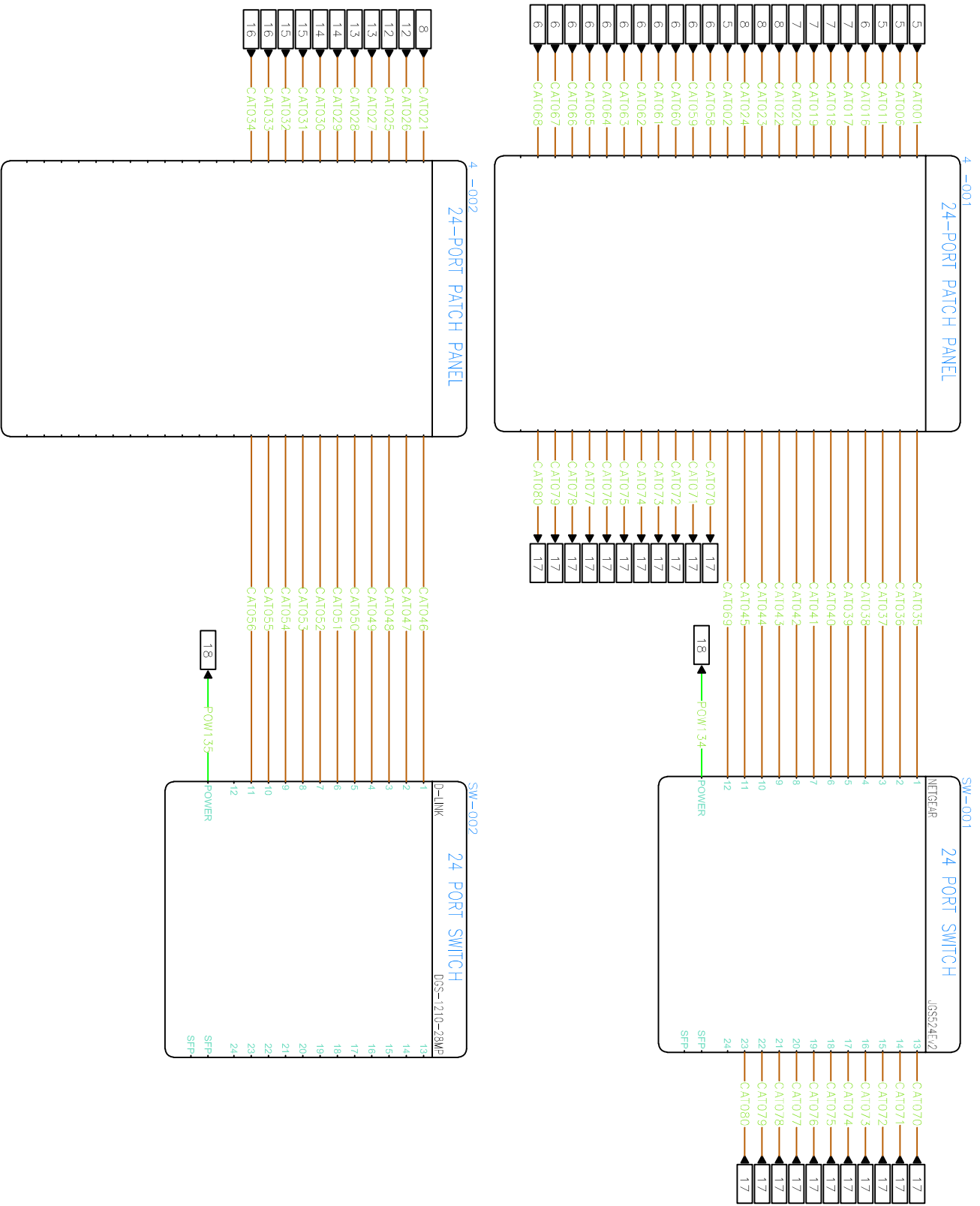

JOB NO 4634-800		
SCALE NONE		
ENGINEER MSF		
DRAWN BY MSF	DATE 12/12/19	
DWG NO K616	REV. 2	CHECKED BY DATE
SHEET NO 17 OF 18		

DWG TITLE
NETWORK

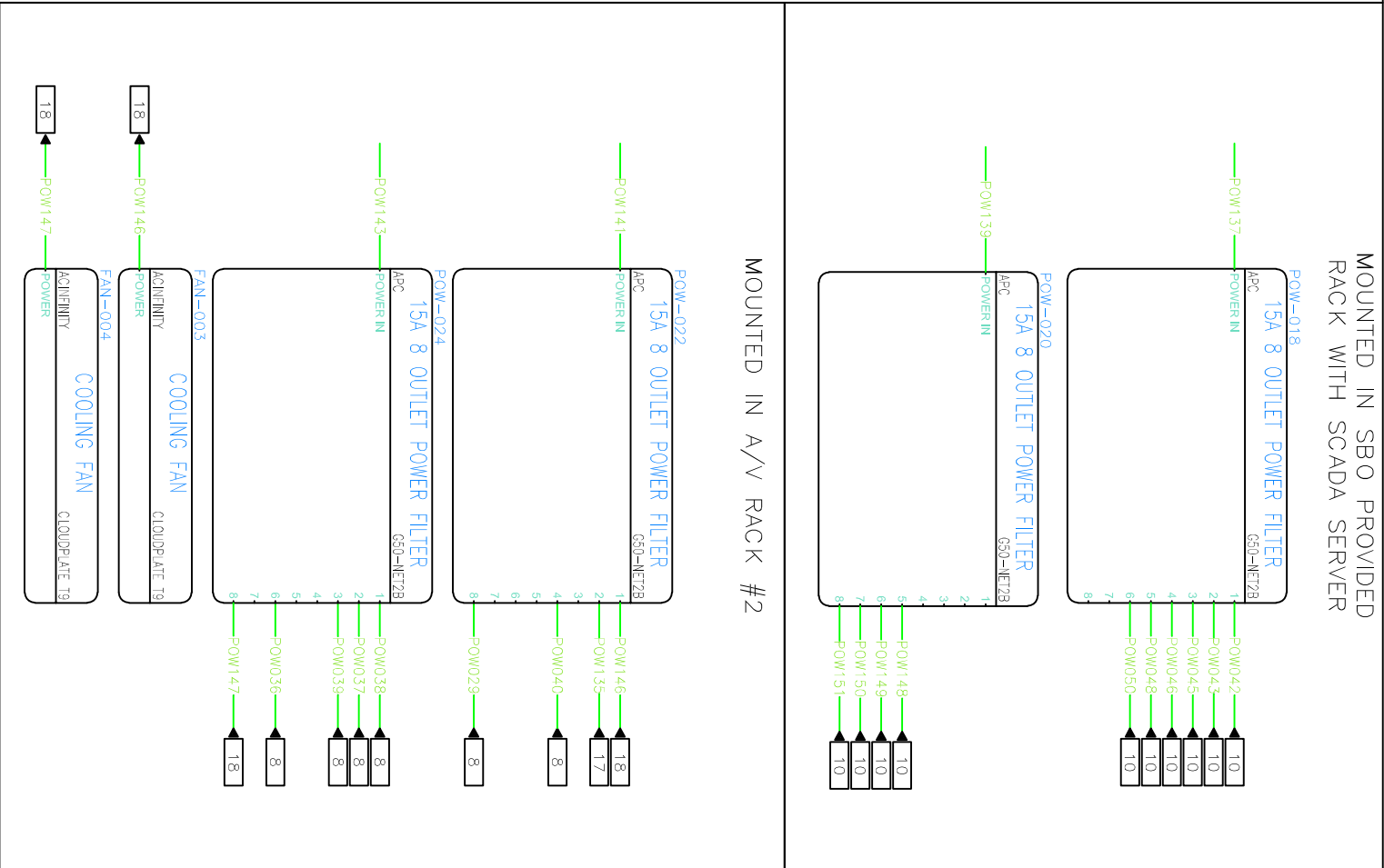
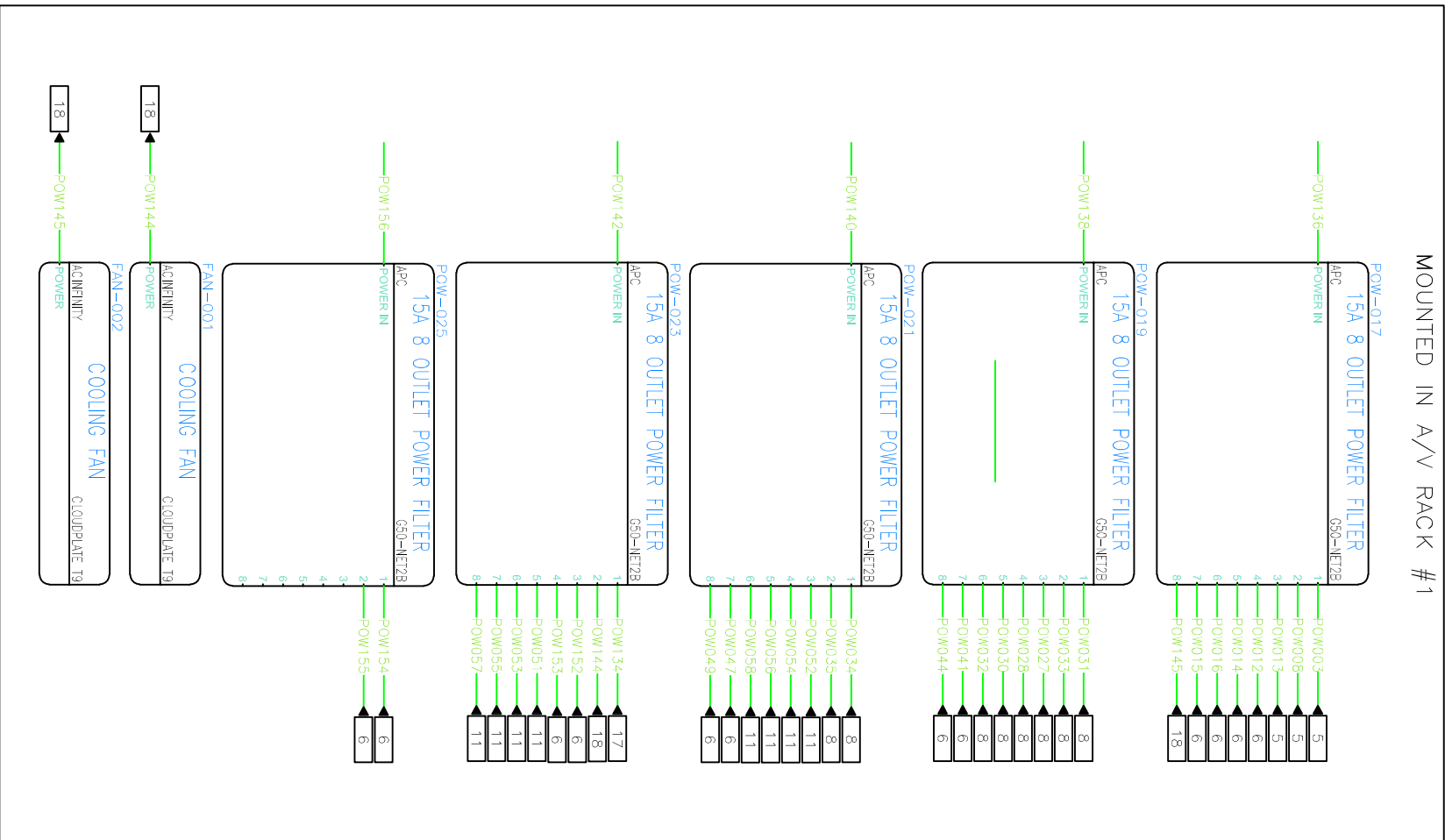

DWG TITLE RACK POWER		JOB NO 4634-800
		SCALE NONE
DWG NO K617		ENGINEER MSF
		DRAWN BY MSF
REV. 2	CHECKED BY DATE	DATE 12/12/19
		SHEET NO 18 OF 18